

flexeserve®

Operation Manual



Flexeserve Hub
Models 600 | 1000

Flexeserve Customer Support

+44 (0) 1455 638300

customer.support@flexeserve.com



Contents	
Introduction	3
Safety Symbols	4
Safety Instructions	5
Specifications	6
Overall Dimensions	7-8
Installation	9
Positioning	10
Moving	10
Electrical Connection	11-12
Equipment Configuration	13
Power ON/OFF	14
Switching On	15
Switching Off	16
Operation	17-20
Display and Merchandising	21
Product Probing	21
Daily Cleaning	22-23
Troubleshooting	24
Spare Parts and Service	25
Disposal of this Equipment	25
Contact Us	26

Introduction

This manual has been developed as a guide to assist with the continued safe operation of the equipment.

The document covers many aspects of use and maintenance; the relevant level of training and competence is required from the operators working with the equipment.

The Alan Nuttall Partnership Ltd cannot be held responsible for any accidents or injuries caused by instructions being carried out incorrectly or by the way the information is depicted. The manual must be read and understood before using the equipment.

This manual has been composed with the utmost care. However, as the result of a constant commitment to development and improvement, it may be the case that your equipment deviates in detail from what is described in this manual.

The following instructions are only intended as guidelines for the installation, operation and maintenance of the equipment. Furthermore, The Alan Nuttall Partnership Ltd accept no liability whatsoever for loss or injury caused by the failure to strictly adhere to the safety guidelines and instructions in this manual, whether due to carelessness, lack of the relevant training, qualification or competence, and during installation, operation, maintenance or repair of the equipment.

This manual should be retained for future use.

Model numbers relating to this operation manual include:

- FH-10D-AU
- FH-10D-EU
- FH-10D-GB
- FH-60L-AU
- FH-60L-AT
- FH-60L-EU
- FH-60L-GB
- FH-60L-GT
- FH-60R-AU
- FH-60R-EU
- FH-60R-GB
- FH-60R-GT

© 2023 The Alan Nuttall Partnership Ltd

Do not copy without written permission from The Alan Nuttall Partnership Ltd. All contents of this document remain the intellectual property of The Alan Nuttall Partnership Ltd.

Safety Symbols

The symbols defined below, which are relied upon for safety, are used on Flexeserve Hub and/or throughout this document.



WARNING/CAUTION

An appropriate safety instruction should be followed or caution to a potential hazard exists.



DANGEROUS VOLTAGE

To indicate hazards arising from dangerous voltages.



HEAVY

This product is heavy and reference should be made to the safety instructions for provisions of lifting and moving.



HOT SURFACE

To indicate that the marked item can be hot and should not be touched without taking care.



INFORMATION

Information provided for trained and skilled operators only.



MAINTENANCE

Maintenance of the equipment must only be undertaken by fully trained, qualified and competent engineers.



PROTECTIVE EARTH (GROUND)

To identify any terminal that is intended for connection to an external conductor for protection against electric shock in case of a fault, or the terminal of a protective earth (ground) electrode.



WASTE OF ELECTRICAL AND ELECTRONIC EQUIPMENT

When the end user wishes to discard this product, it must be sent to separate collection facilities for recovery and recycling.

Safety Instructions

- This equipment may only be used by trained and skilled personnel. Any application that does not conform to the specified use is considered hazardous.
- The equipment must only be used for its intended purpose; any other application will be considered improper. Flexeserve Hub is designed to hot-hold food that has been cooked prior to display only. The equipment is not for cooking.
- Heated areas of Flexeserve Hub exceed 70°C (158°F): only touch the components used to control the equipment.
- Food products are to be pre-cooked to the appropriate temperature and displayed in suitable containers/packaging.
- Do NOT place anything heavier than 20kg (44lbs) on to the display surface.
- Do NOT operate the equipment without the fan cover plate fitted.
- Do NOT place anything on the fan cover plate.
- Do NOT cover or block exhaust vents or fan plates.
- Children should not be allowed to play with or be near the equipment.
- Before using the equipment:
 - Inspect the power cable for damage. If damaged, disconnect and isolate Flexeserve Hub;
 - Ensure that there are no foreign or combustible objects other than approved Flexeserve Hub accessories or approved food packaging in contact with the heated surfaces;
 - Ensure that shelves or display racks are fitted correctly to avoid the risk of injury.
- Switch off the unit:
 - When not in use;
 - Before carrying out any maintenance task, such as cleaning;
 - Before moving the equipment.

To ensure that the equipment remains in optimum technical condition, maintenance work should be carried out at least once a year by an approved Flexeserve Service Provider.

The end user is fully responsible for the fulfilment of locally applicable safety regulations and guidelines at all times.

Any safety symbols, warnings and/or instructions attached to the equipment are part of the safety features. They must not be covered or removed, and must be present and legible during the life of the product. Immediately replace damaged or illegible symbols, pictograms, warnings and instructions.

Specifications

The Flexeserve Hub range of products detailed within this manual is a series of floor standing heated displays for the presentation of pre-cooked food products in a suitable container or packaging in commercial outlets.

The Flexeserve Hub models are provided with adjustable position wire shelves. There is also the option to provide merchandising trays, racks and pizza shelves.

Flexeserve Hub maintains the food products to a fixed temperature between 65°C (149°F) and 95°C (203°F) by means of an air circulation heater.

NOTE

Each Flexeserve Hub will be factory set to maintain a minimum of 90°C (194°F) air temperature.

Flexeserve Hub models are supplied on castors; the front brake castors can be locked when the unit is in position.

The Flexeserve Hub range is cord connected and supplied with an appropriate cord set, and for indoor use only.

The ambient conditions required to operate the equipment are between 18°C (65°F) to 40°C (104°F), with a maximum relative humidity of 70%.

Overall Dimensions - Model 600

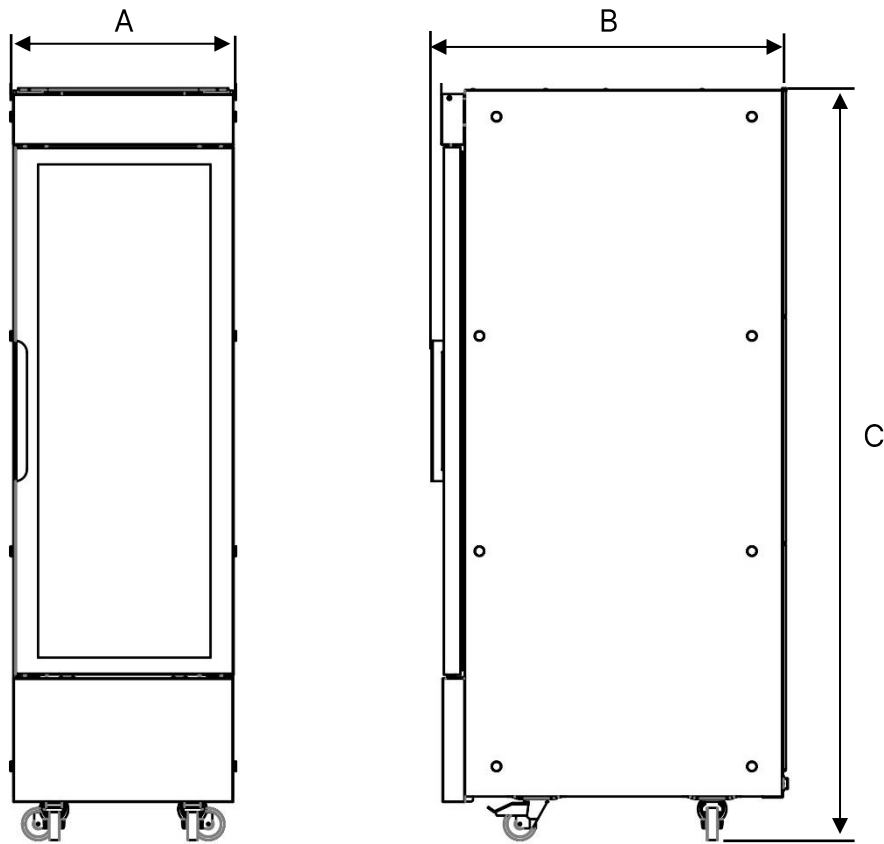

A - WIDTH	B - DEPTH	C - HEIGHT	WEIGHT
559mm (22")	891mm (35")	1871mm (73.6")	190kg (418.9lb)

Overall Dimensions - Model 1000

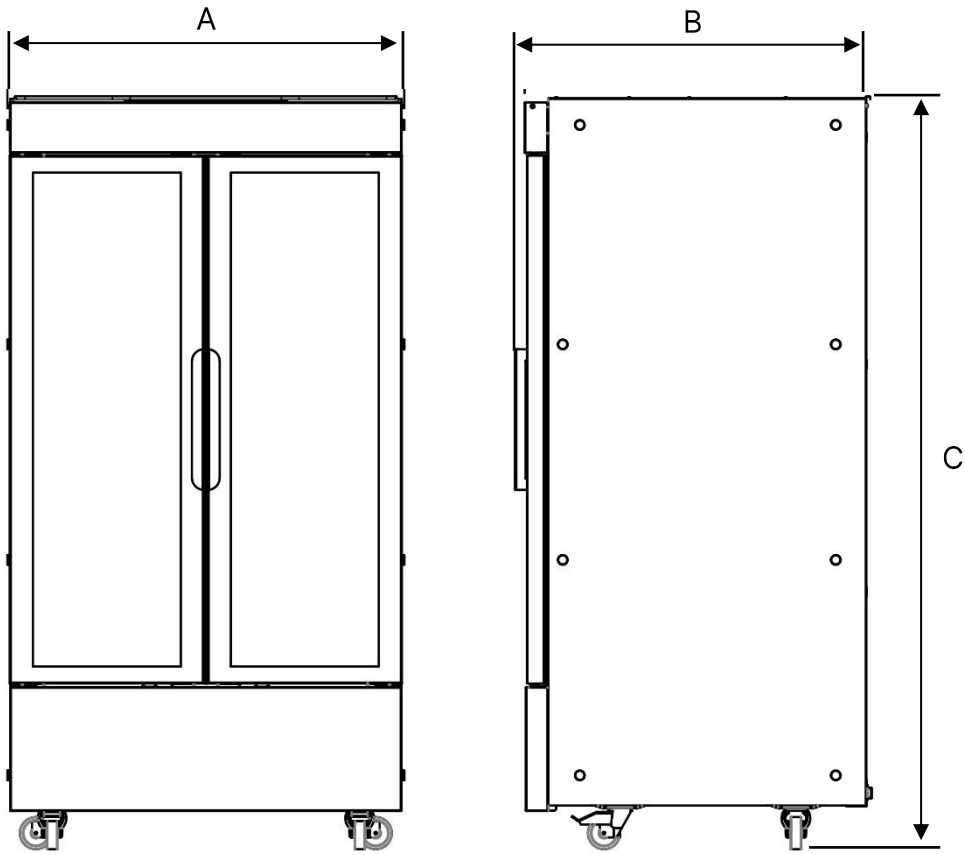

A - WIDTH	B - DEPTH	C - HEIGHT	WEIGHT
984mm (38.7")	890mm (35")	1871mm (73.6")	288kg (634.9lb)

Installation



WARNING

Installation of these units should be carried out by appropriately qualified and skilled personnel. Failure to do so may invalidate the warranty.

The equipment will be delivered to site boxed on a pallet.

Remove all packaging materials from the unit and dispose of correctly, in accordance with local regulations.

Care must be taken when removing packaging so not to damage or scratch the painted, glass or stainless-steel surfaces.

Remove all temporary tape.

Prior to the first use, clean with a proprietary food-safe cleaning solution, following the instructions set out in the cleaning and maintenance section of this manual. Ensure that an excessive amount of water is NOT used. Do NOT use aggressive detergents.

If there are any signs of damage, contact Flexeserve Customer Support immediately. Failure to report faults, defects or missing items upon delivery may incur charges.

Ensure that safe manual handling practices are employed at all times. Flexeserve Hub should be placed into position using the correct procedures, in line with local and regional safety policies.

The following considerations must be given to the site of installation:

- Avoid placing sources of heat near the unit.
- Do NOT install the unit near other equipment that generates high temperatures in order to avoid damage.
- The equipment should be sited so that it is not affected by draughts from doors or air conditioning systems. Temperature fluctuations are likely to occur if the equipment is not sited appropriately. This will have an adverse effect on product temperatures and may increase running costs.
- Ensure that the floor supports the weight of the unit at full capacity.
- Ensure that the unit is installed on a flat, even surface.
- A gap of at least 50mm (2 inches) should be left between the back of the equipment and any wall/solid surface.

The supporting or surrounding surfaces for the unit must be:

- Non-combustible;
- Level, flat and even;
- Able to support the unit's weight at full load, without undergoing deformation or structural failure;
- Immovable.

Positioning



WARNING

Installation of these units should be carried out by appropriately qualified and skilled personnel. Failure to do so may result in unsafe operation or personal injury.



WARNING

Adequate provision should be made for lifting and positioning the unit to avoid risk of damage or injury. Sufficient personnel should be available to handle each unit without contravening company or site health and safety policies.

It is recommended that a minimum of two persons are required for placing the equipment into position.

The equipment must be kept in the vertical orientation at all times.

A gap of at least 50mm (2 inches) should be left between the back of the equipment and any wall/solid surface.

Once the unit is placed in the desired location, it should be prevented from being moved.

Flexeserve Hub models have castor brakes fitted that should be applied. The castor brakes are located to the front elevation of the unit, as shown in the illustration below.

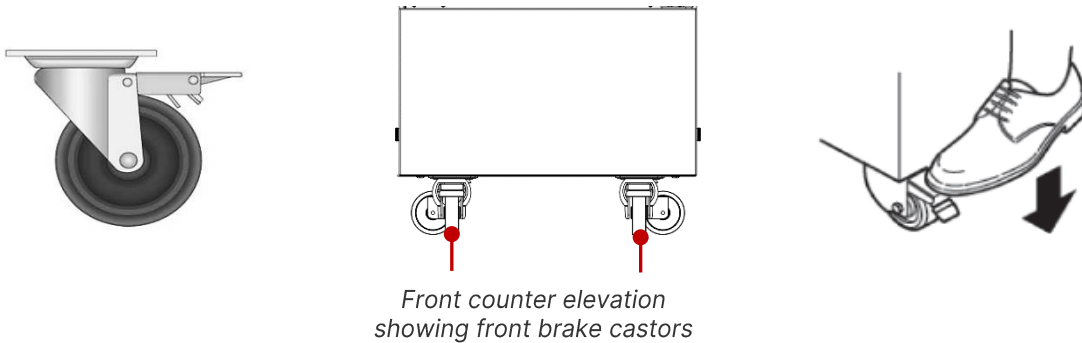

Moving

Before moving the unit, isolate and disconnect the power cord from the wall socket. Stow the electrical power cord so that it does not become damaged during repositioning.

The units are not suited to pass over ledges or obstacles. Make sure that the wheels can move freely and never come into contact with the power cord (see figure below).

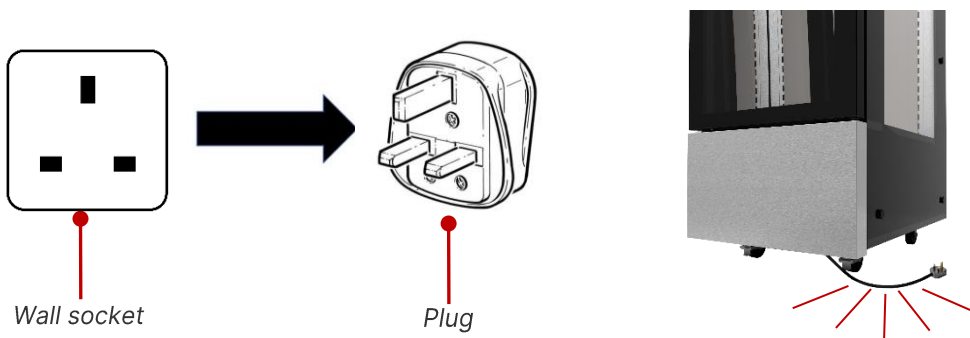

Electrical Connection



WARNING

Connection must only be carried out by suitably trained, qualified and skilled engineers, in accordance with all regional and local electrical codes.

Flexeserve Hub units are designed to be installed with dedicated power cords.

Flexeserve Hub units are typically supplied with an appropriate IEC 60309 appliance “Commando” style coupler rated for the appropriate voltage and current of the Flexeserve Hub unit variant purchased.

Flexeserve Hub units can be supplied without an appliance coupler for attachment as either a permanently connected appliance to a dedicated isolator or may be fitted with a pre-approved regional plug.

The equipment must be connected to a branch circuit protected grounded supply in accordance with local electrical codes.

Each unit must have its own dedicated power supply.

NOTE For electrical ratings of the unit, refer to the electrical rating sticker located inside the front top panel of Flexeserve Hub. An example is shown below.

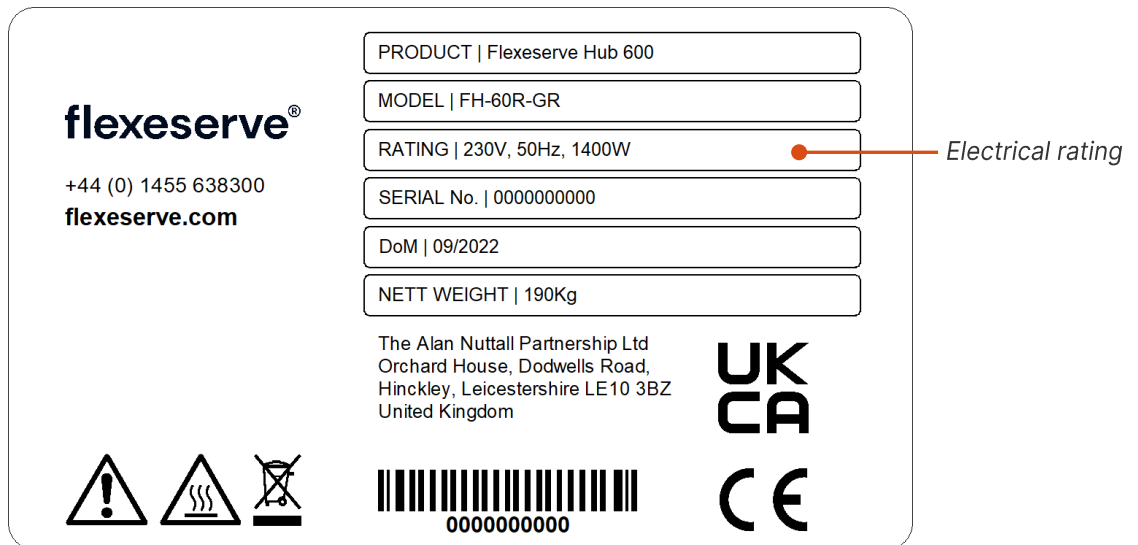

It is highly recommended to provide the equipment with an accessible means of isolation external to the equipment, i.e. a wall isolator switch.

Electrical Ratings

The units are electrically rated for 230V 1PH, 50Hz electrical supply.

MODEL	TOTAL POWER
600	1400 W
1000	2700 W



WARNING

For all types of installation, ensure that the power cord is in a safe position. Under no circumstances should any electrical cables or power points be installed directly in contact with any part of the unit or pose a risk to safety.

If the mains power lead becomes damaged, isolate the equipment removing from service immediately until a replacement is fitted by a suitably trained, qualified and skilled engineer, in accordance with all regional and local electrical codes.

Equipment Configuration



CAUTION

The unit will not operate correctly without the wire shelves in the correct position.

Slide signage into the ticket strip. Close the door(s) when not in use.

The door must be open in order to open the front top cover and access the control box.

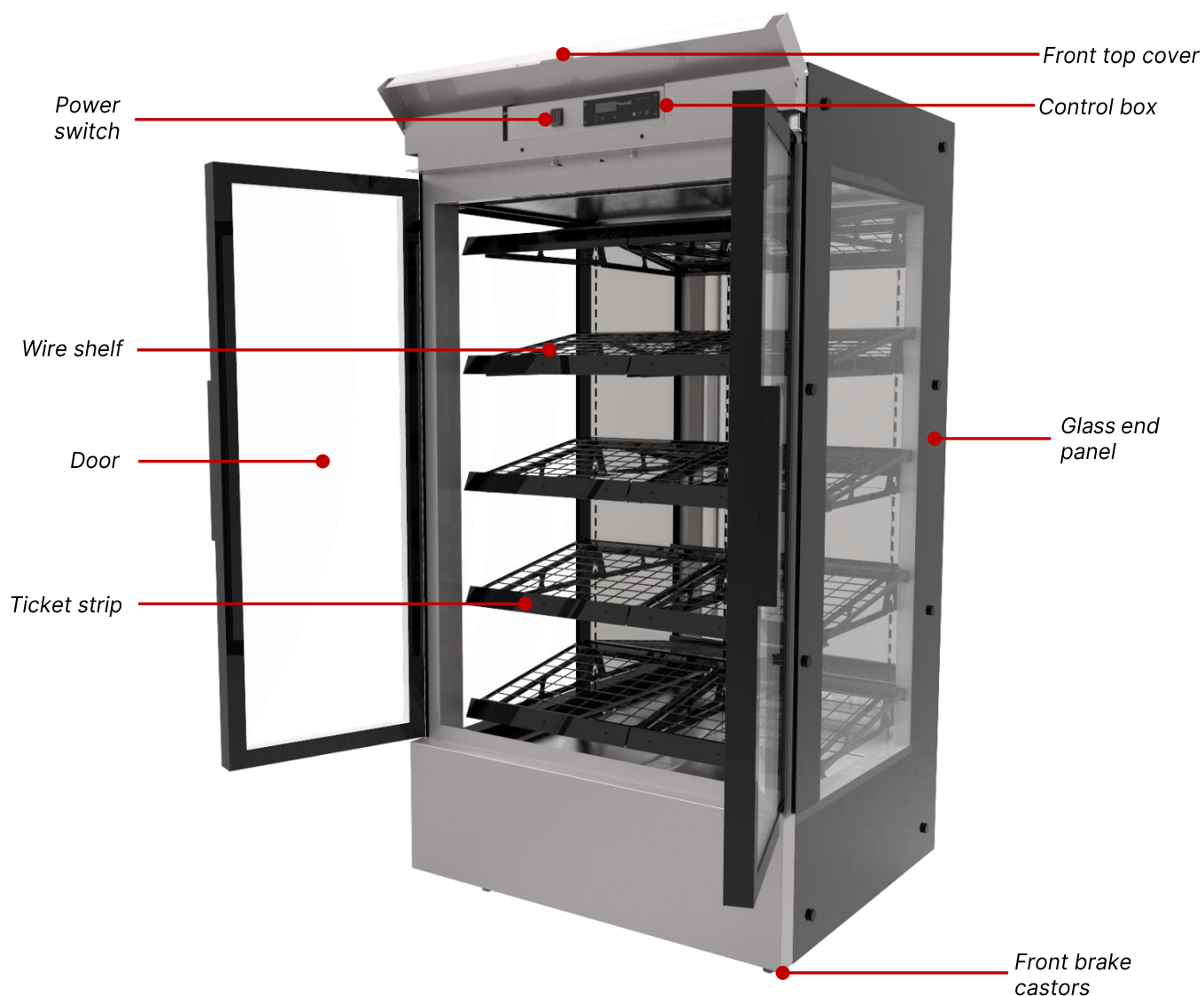

Power ON/OFF

Each Flexeserve Hub is supplied with a power switch to turn the unit on or off. This is located behind the front top cover of Flexeserve Hub.

The door must be open in order to open the cover. The controls are designed to slide out of the unit for access and use.

Set the mains power switch to the 'I' position to apply power to the unit and set to the 'O' position to power off.

Control Panel

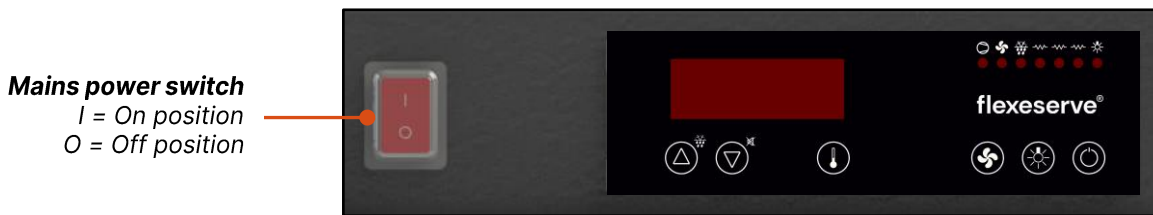

Mains power switch
I = On position
O = Off position



WARNING

In an emergency, switch off the unit and isolate fully from the mains supply. Ensure that you take time to familiarise yourself with this location.

To fully isolate the unit, disconnect the incoming mains supply by disconnecting the power cord from the supply.

Switching On



WARNING

In an emergency, switch off the unit and isolate fully from the mains supply. Ensure that you take time to familiarise yourself with this location.



CAUTION

The internal parts will become hot, reaching temperatures above 70°C (158°F).

Each of the model variants are supplied with one set of controls. The controls are located behind the front cover at the top of the equipment. The door must be open in order to open the cover. The controls are designed to slide out of the unit for access and use.

Ensure that the equipment is empty and clean prior to switching on. Check that the equipment is connected to a power socket.

Before switching the equipment on, it is the operator's responsibility to visually inspect the equipment to ensure that there is no damage that may compromise safety.



Set the mains isolator switch to the 'ON' position and the controller will illuminate. The display will show the current temperature. The equipment will begin to heat and reach the established temperature set-point automatically, generally 90°C (194°F).

The unit should be left empty without interference and may take up to 45 minutes to reach operating temperature. No products should enter the display area until it has reached the correct operating temperature.



WARNING

Do NOT place unpacked food products directly on to the wire shelves.

Switching Off



WARNING

When switched off or disconnected from the power source, the internal parts may still be hot, and may take up to two hours to cool down.



CAUTION

Cleaning and maintenance should only be carried out when the unit has sufficiently cooled and with the mains supply electrically isolated.

To switch off the unit, set the mains power switch to the 'OFF' position.



To fully isolate the unit, disconnect the incoming mains supply by disconnecting the power cord from the supply.

Operation

Adjusting Temperatures



WARNING

Only if the operator has been trained and is skilled in the operation of the equipment covered in this guide should this information be followed.

Do NOT attempt to cook products on the shelves of the equipment.

Do NOT place cooking vessels on the shelves of the equipment.

Do NOT place anything heavier than 25kg (55.1lbs) on to the display surface.

The equipment will only maintain the temperature of products that have initially been cooked, prior to display. Ensure that food is transferred to the display area immediately after cooking in appropriate containers or packaging.

Ensure that temperatures of the displayed products are checked and recorded on a regular basis, in accordance with local regulations.

The temperature of the unit is displayed by the controller and is for indication of operating temperature only. Do NOT use this as a reference to core temperature of foods on display; regular temperature probing of the product is to be performed.



The minimum and maximum set-point values have been pre-set in the factory to prevent the equipment holding temperatures from being adjusted beyond legal and safety limits. These can only be adjusted by a Flexeserve appointed engineer.

To view the set temperature of the unit, press the temperature button for half a second, and then release.

To change the temperature of the unit, press and hold the temperature button and press the temperature adjustment buttons to increase (▲) or decrease (▼) the temperature. When the temperature button is released, the new value is stored. After the temperature has been set, the display will revert back to the operating temperature, which will rise or fall as it reaches the set temperature.

Using the Product Timer

Some units are supplied with a product timer containing pre-configured information on the shelf contents. The product timer contains information on the shelf contents, the time required to hold the contents and an alarm to alert the operator when products should be removed from the shelves.

To access the shelf information in the product timer, touch the orange and white fan icon in the bottom left-hand corner of the screen (Figure 1).

Figure 1

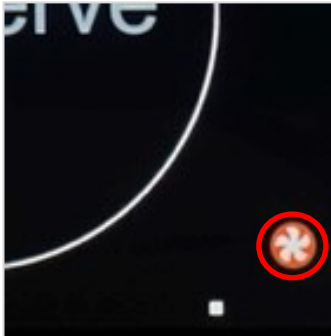

To alter the shelf information, touch the 'Settings' icon on the top-right of the screen (Figure 2).

Figure 2

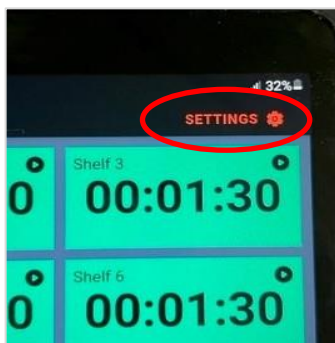

To change the number of shelves, touch the timer line and slide until it reaches the number of shelf timers required (Figure 3).

Figure 3

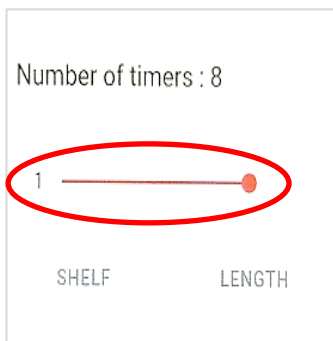

To set the timer length and warning time on a shelf, touch the cog icon on the right-hand side of the applicable listed shelf (Figure 4). Use the '+' and '-' icons to adjust the timer length and warning time to the desired times (Figure 5). On the below example (Figure 6), the '01' is the hours, the '30' is the minutes and the '00' is the seconds.

Figure 4

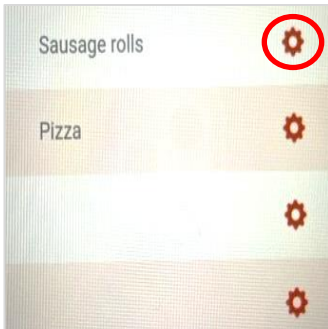

Figure 5

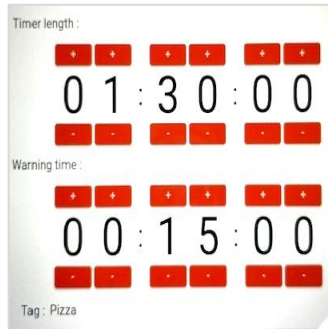
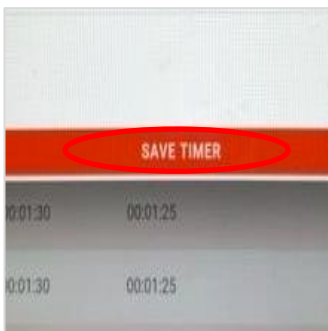

Figure 6



Touch the 'Save Timer' icon to set the timer length and warning time (Figure 7).

Figure 7



To change the name of a shelf, touch the cog icon on the right-hand side of the applicable listed shelf (Figure 4). Touch the 'Tag' field below the timers and the keyboard will appear below (Figure 8). Type the shelf name into the 'Tag' field using the keyboard (Figure 9). Touch the 'Save Timer' icon to set the shelf name (Figure 7).

Figure 8

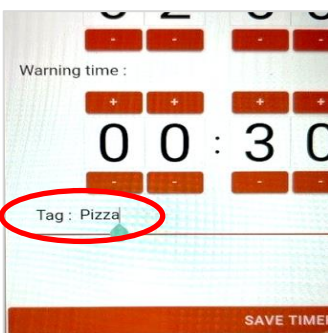
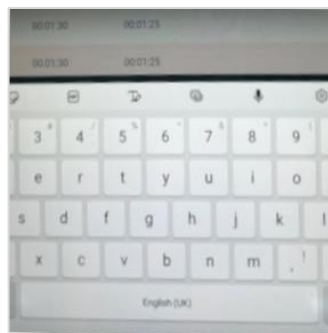
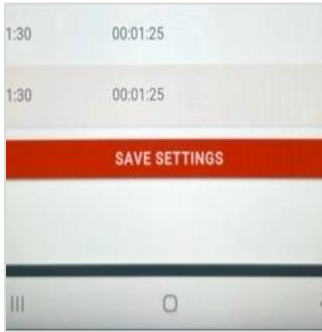

Figure 9



Touch the 'Save Settings' icon at the bottom of the screen to set all the changes that have been made (Figure 10).

Figure 10



To start the timer on a shelf, touch the applicable shelf icon once and the timer will begin (Figure 11). To pause the timer on a shelf, touch the applicable shelf icon once more (Figure 12). To reset the timer on a shelf, touch and hold the applicable shelf icon and the timer will reset to its original time (Figure 13).

Figure 11



Figure 12

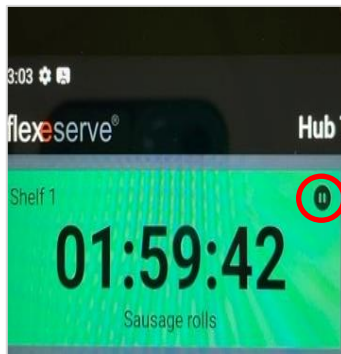
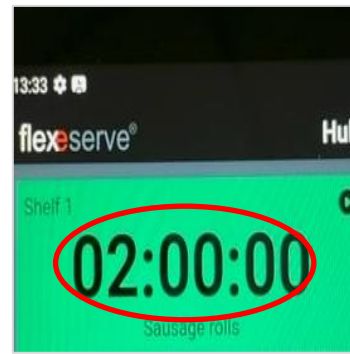

Figure 13



Once a shelf has reached its set warning time, an alarm will sound for 3 seconds and the shelf icon will flash amber to alert you (Figure 14). Once a shelf has reached the end of its set time, the shelf icon will flash red and the alarm will sound for 10 seconds (Figure 15). The shelf icon will continue to flash red and count down until the shelf timer has been reset (Figure 16).

Figure 14



Figure 15

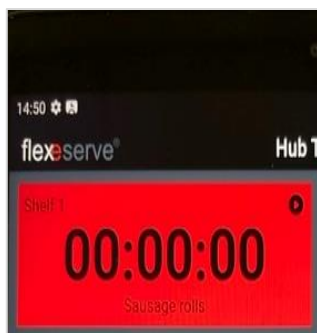

Figure 16



Flexeserve Hub is manufactured to comply with health and safety regulations. You must operate the equipment properly using only calibrated temperature probes to ensure food is thoroughly cooked to the safe standards according to local regulations.

Display and Merchandising

Different products require varying display times according to their core temperature. These must be considered to ensure the best quality and safe temperature for consumption is achieved. The Alan Nuttall Partnership Ltd does not accept responsibility for variances or losses of quality that occur due to product differences.

All items placed in Flexeserve Hub should be in the correct packaging/containers, in line with in-store procedures and best practice. Remove products in damaged packaging from the equipment and clean as soon as possible.

The door handle must be used at all times when opening and closing the door. Ensure that the door is fully closed once the products have entered the display area.

Product Probing



INFORMATION

Legal requirements dictate all products displayed for an extended period within any heated display area should be periodically probed throughout trading to ensure the core temperature of the product is above the legal holding temperature of the local authority. Refer to in-house operations manual for product probing instructions.

It is beneficial to enter the product into the holding unit as hot as possible for that particular food product to maximise shelf-life at the safe temperature.

The equipment is not designed to increase product temperature; the products gradually fall and regulate in temperature throughout the display period to ensure good product quality. It is critical that the entry core temperature is as high as possible so the maximum display time is achieved. The product will fall in temperature during its display time regardless of the entry temperature; therefore, a low entry temperature will reduce display time.

At the end of recommended display times, any unsold products should be removed, reduced and disposed of, in accordance with company and food safety standards.

The Alan Nuttall Partnership Ltd does not take responsibility for variances or loss of quality that may occur due to product differences.

Recording Product Temperatures

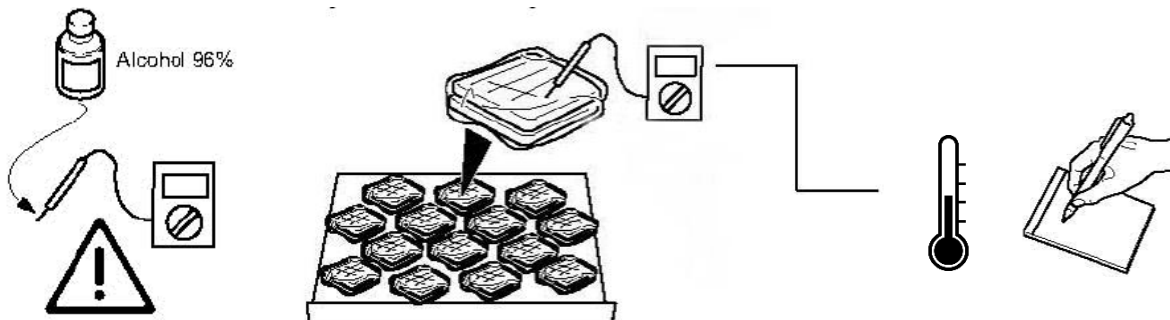

The core temperature of the products should be periodically probed and recorded according to local authority guidelines.

Daily Cleaning



CAUTION

Isolate the equipment fully before any cleaning is undertaken.



CAUTION

Ensure that the equipment has completely cooled before any cleaning is undertaken.

Only suitably trained personnel should carry out cleaning procedures.

Ensure that the power has been isolated.

Ensure that all display surfaces are allowed to cool to room temperature.

Ensure that water is not allowed to pool or sit in the unit. Sanitise and dry, as required.



WARNING

If the shelves are damaged, discontinue use.

Do NOT use excessive amounts of water.

Do NOT clean the equipment with high-pressure cleaners, jets of hot water or high-pressure steam. All traces of food debris should be removed completely.

Do NOT use abrasive cleaning products as these could damage the finish of the equipment. It is recommended that non-abrasive cleaning products are used. Do NOT use glass cleaning products.

Wire Shelves

The wire shelves can be removed and cleaned by unhooking from the shelf brackets, as shown below.

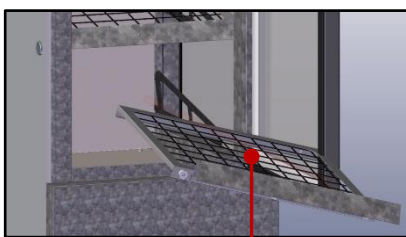

Wire shelf

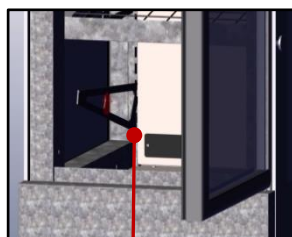

Unhook wire shelf
from bracket

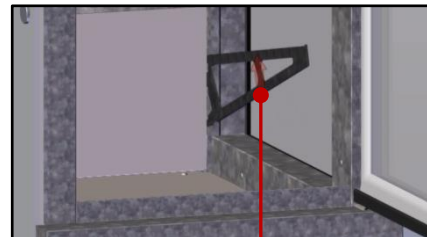

Shelf bracket

Clean with a damp cloth and a mild detergent suitable for stainless steel.

Once the wire shelves are removed, crumbs and debris can be cleaned out of the unit. Take care not to sweep crumbs into the air outlet at the front of the unit.

Reverse the process to reassemble the wire shelves.



Base Tray

Ensure that the unit is empty before cleaning the base tray.

Figure 1



Figure 2



Figure 3



Figure 4



Use the handle to lift out and remove the base tray (Figure 1). Clean using mild detergent and a soft cloth.

Carefully remove the crumb catcher using the 2 finger holes (Figures 2 & 3). Dispose of crumbs and wipe over using mild detergent and a soft cloth.

Use a vacuum to remove any crumbs and debris. Wipe over the base fan cover using mild detergent and a soft cloth.

Wipe the back panel using mild detergent and a soft cloth.

Reassemble the base tray and crumb catcher once the above cleaning process is complete.



WARNING

Do NOT use aggressive detergents. Ensure that all parts are refitted before use of the unit.

The Alan Nuttall Partnership Ltd cannot take responsibility for any malfunction or damage if these cleaning procedures are not adhered to.

Troubleshooting



CAUTION

Never attempt to open electrical connection enclosures. Only approved, trained and competent engineers should access the base of the unit and electrical areas.



WARNING

The information provided is for guidance only. The Alan Nuttall Partnership Ltd cannot be held responsible for any accidents or injuries caused by instructions being carried out incorrectly, or by the way the information is depicted.

Fault	Potential Cause	Solution
Unit is not operating.	No power.	Check that the switch on Flexeserve Hub is switched on.
		Check that the unit is plugged into a working socket.
		After the above, contact Customer Support.
Unit is not operating at temperature.	Parts are missing.	Ensure that wire shelves are in place.
	Store conditions.	Refer to the 'Specifications' page of this Operation Manual for the ambient conditions required.
	Set point.	Ensure that the unit is set to the correct temperature.
	Over-temperature thermostat has operated causing a blank display.	Contact Customer Support.
	Fan is spinning but cold air is blowing.	Contact Customer Support.
Lights are not working.	Light unit has failed.	Contact Customer Support.
Alarm is sounding.	Door has been left open.	Ensure that the door is closed correctly.

This information is provided for guidance only and is not exhaustive. Always use best practice fault-finding techniques to establish and eliminate faults.

Some faults must only be investigated by a trained and qualified Engineer. For assistance, contact **Customer Support.**

Spare Parts and Service

For all spares and service requirements, please contact **Customer Support**.

Your product can be identified by the electrical rating sticker located inside the front top panel of Flexeserve Hub.

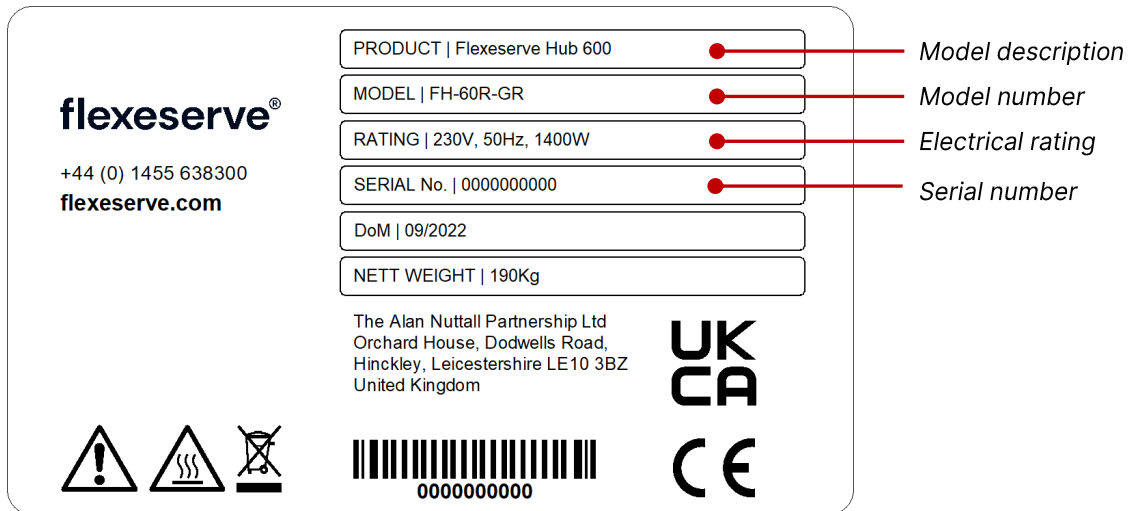

To help us process your service call efficiently, we will require the following information:

1. Serial number;
2. Description of fault;
3. Site telephone number;
4. Site address.

Disposal of this Equipment



WASTE OF ELECTRICAL AND ELECTRONIC EQUIPMENT

Penalties may be applicable for incorrect disposal of waste, in accordance with national legislation.

This product should not be mixed with general household waste. For proper treatment, recovery and recycling, please return this product to Flexeserve or take this product to a designated collection point where it will be accepted free of charge. Contact details can be found on the following page.

Disposing of this product correctly will help save valuable resources and prevent any potential negative effects on human health and the environment, which could otherwise arise from inappropriate waste handling.

Contact Us

At Flexeserve we continue to make improvements. Feedback regarding any concerns relating to this unit is always welcome.



**Customer Support
& Enquiries**

+44 (0) 1455 638300



**Customer Support
Enquiries**

customer.support@flexeserve.com
info@flexeserve.com



**Customer Support
& Enquiries**

FLEXESERVE

The Alan Nuttall Partnership Ltd - Orchard House, Dodwells Road,
Hinckley, Leicestershire, LE10 3BZ United Kingdom



Website

flexeserve.com

